

EL Micro Multi CH1216-C8W80801H-AM

Preliminary

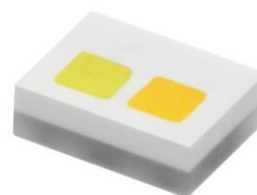

Features

- Package : Cool White & Warm White LEDs on Ceramic substrate
- Typ. Color Temperature : Cool White 5180K ~ 6680K ; Warm White 2580K ~ 3200K
- Typ. Luminous Flux : Cool White 23 lm ; Warm White 21lm@ 80mA
- Viewing angle : Cool White 120° and Warm White 120°
- ESD : up to 8KV
- MSL : 1
- Preconditioning : According to JEDEC J-STD 020D Level 1
- Qualifications : According to AEC-Q101
- Compliance with RoHS and REACH

Applications

- Automotive Interior Lighting , Dashboard, Switch, Reading lamp, Audio and Car Infortainment,etc
- Backlight: LCD, switches, symbol, mobile phone and illuminated advertising.
- Ideal for coupling into light guides.
- Optical indicator.
- General applications.

Contents

1. Characteristics	3
2. Absolute Maximum Ratings	4
3. Characteristics Graph	5
4. Binning Information	11
5. Part Number	18
6. Ordering Information	19
7. Mechanical Dimension	20
8. Recommended Soldering Pad	21
9. Reflow Soldering Profile	21
10. Packaging Information	22
11. Handling of Silicon Resin for LEDs	24
12. Precaution for Use	25

1. Characteristics

Parameter		Symbol	Min.	Typ.	Max.	Unit	Condition
Forward Current	CW , WW	I_F	10	80	120	mA	---
Luminous Flux ^{[1][2][3]}	Cool White	Φ_v	20	23	33	lm	$I_F=80mA$
	Warm White		20	21	33		
Forward Voltage ^[4]	Cool White	V_F	2.75	2.90	3.50	V	$I_F=80mA$
	Warm White		2.75	2.90	3.50		
Viewing Angle	CW , WW	ϕ	---	120	---	deg	$I_F=80mA$
Color Temperature	Cool White	K	5180 (53A)	---	6680 (64D)	K	$I_F=80mA$
	Warm White		2580 (27A)	---	3200 (30D)		
Chromaticity coordinates	Cool White	x	---	0.322	---	NA	$I_F=80mA$
		y	---	0.336	---		
	Warm White	x	---	0.466	---	NA	$I_F=80mA$
		y	---	0.422	---		
Thermal Resistance (Junction to Solder)	Real	$R_{th JS real}$	---	12	---	K/W	$I_F=80mA$
	Electrical	$R_{th JS el}$	---	10	---		

Notes:

- Luminous Flux measurement tolerance: $\pm 8\%$.
- The data of Luminous Flux measured at thermal pad=25°C.
- Typical Luminous Flux or light output performance is operated within the condition guided by this datasheet.
- Forward voltage measurement tolerance: $\pm 0.05V$.
- The V_F range shown in the table above indicates 99% output.
- Tolerance of Chromaticity Coordinates x,y : ± 0.005 .
- All color CRI > 80.

2. Absolute Maximum Ratings

Parameter	Symbol	Ratings		Unit
		Cool White	Warm White	
Reverse Voltage	V_R	Not designed for reverse operation		V
Power Dissipation	P_d	420	420	mW
Max. DC Forward Current	I_F	10 ~ 120		mA
Surge Current	I_{FM}	750		mA
Junction Temperature	T_J	125		°C
Operating Temperature	T_{opr}	-40 ~ +110		°C
Storage Temperature	T_{stg}	-40 ~ +110		°C
ESD Sensitivity (R=1.5kΩ, C= 100pF)	ESD_{HBM}	8		kV
Soldering Temperature	Reflow	260°C for 30 sec		°C

3.Characteristics Graph

Wavelength Characteristics Relative Spectral Distribution
@ Ts = 25°C, If=80mA

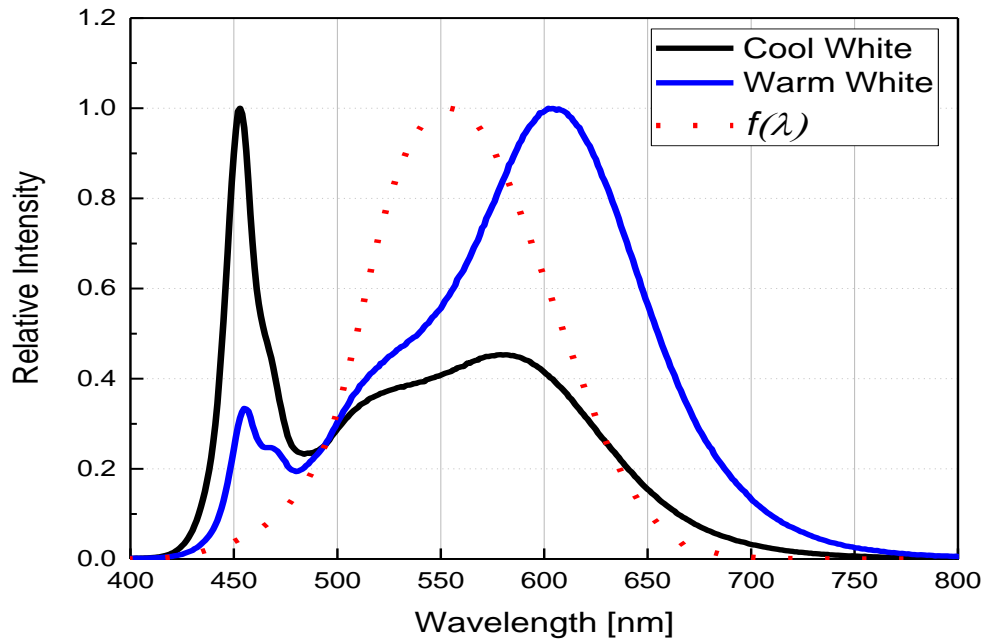

Typical Diagram Characteristics of Radiation

$$\Phi_V / \Phi_V(0^\circ) = f(\varphi)$$

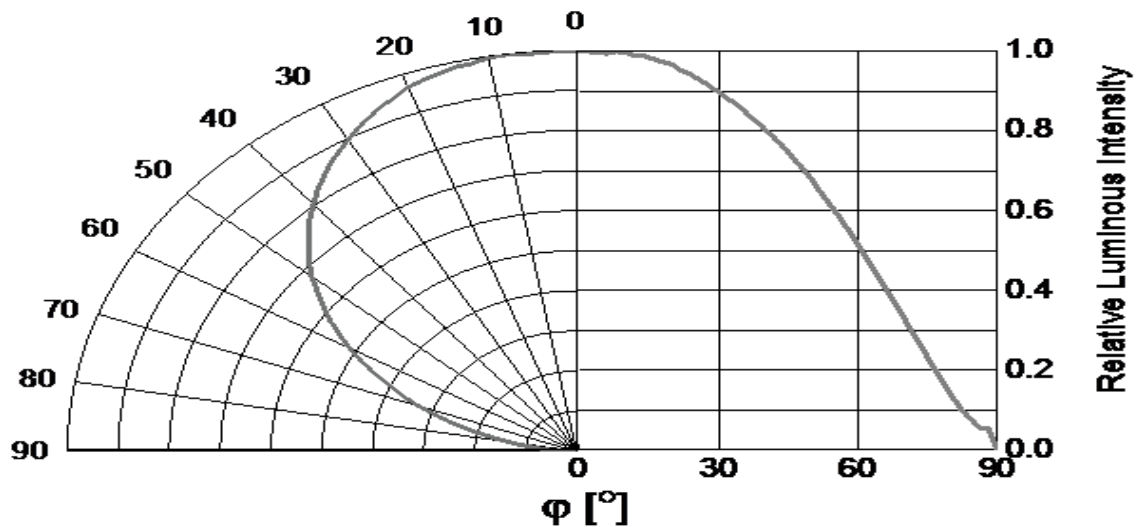

Notes:

1. φ is the off axis angle from lamp centerline where the luminous intensity is 1/2 of the peak value.
2. View angle tolerance is ± 5

Forward Current vs. Forward Voltage
@ Ts = 25°C

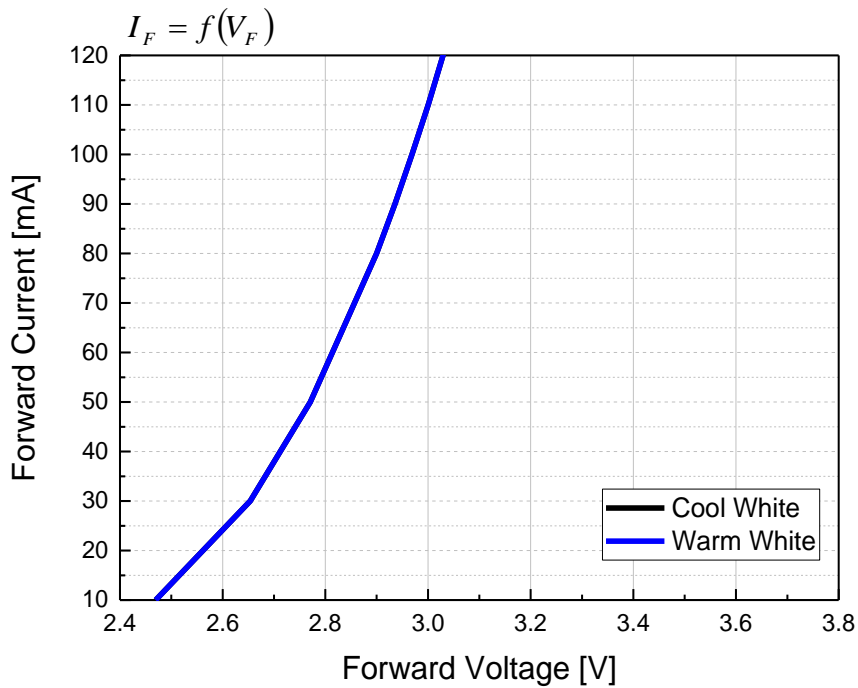

Relative Luminous Flux vs. Forward Current
@ Ts = 25°C

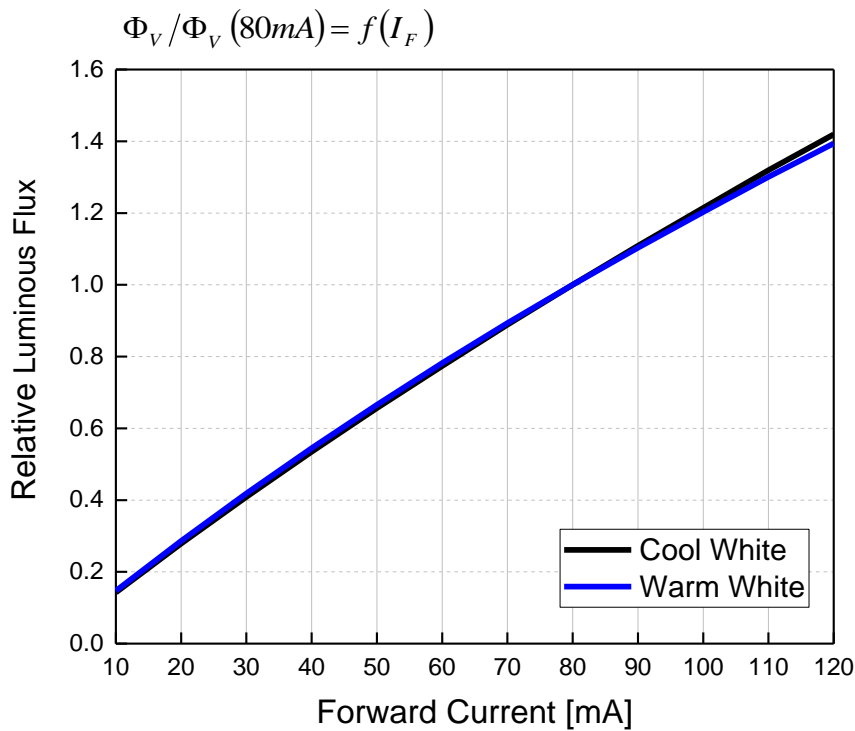

Chromaticity Coordinates Shift vs. Forward Current
@ Ts = 25°C (CW)

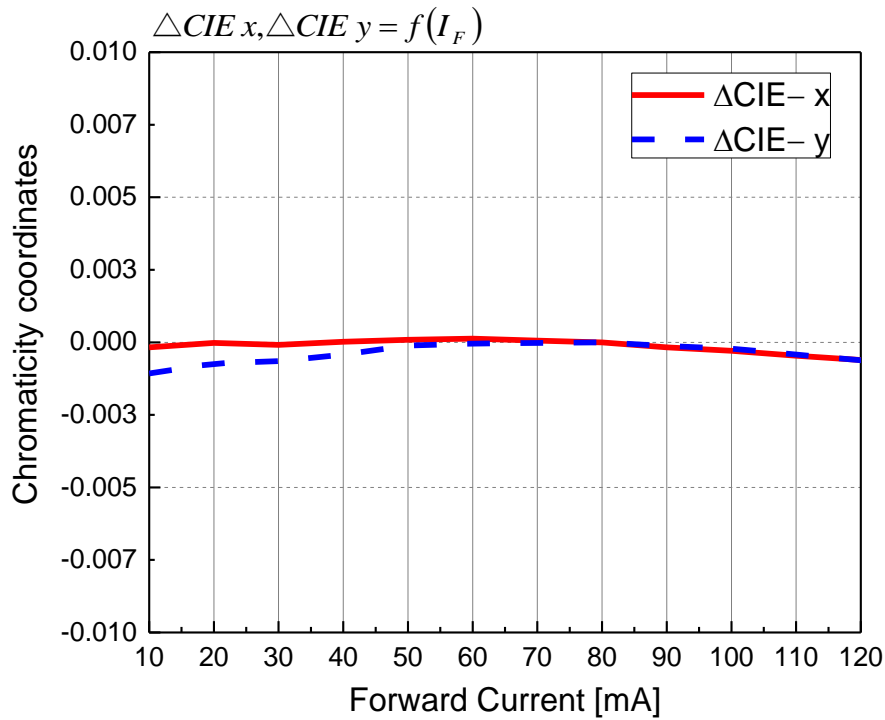

Chromaticity Coordinates vs. Forward Current
@ Ts = 25°C (WW)

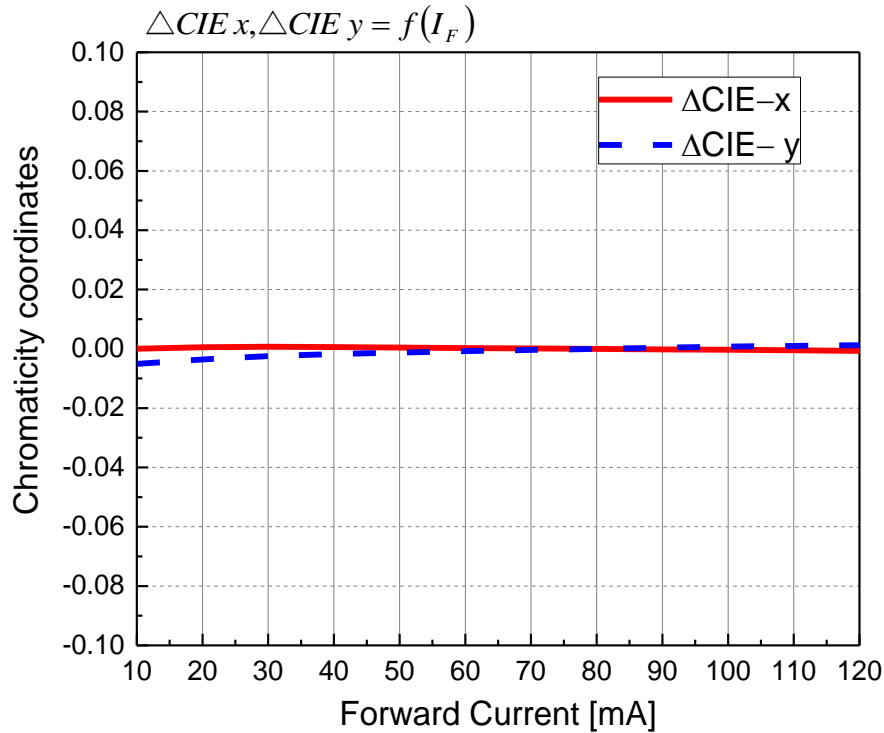

Relative Forward Voltage vs. Junction Temperature
@ $I_F=80\text{mA}$

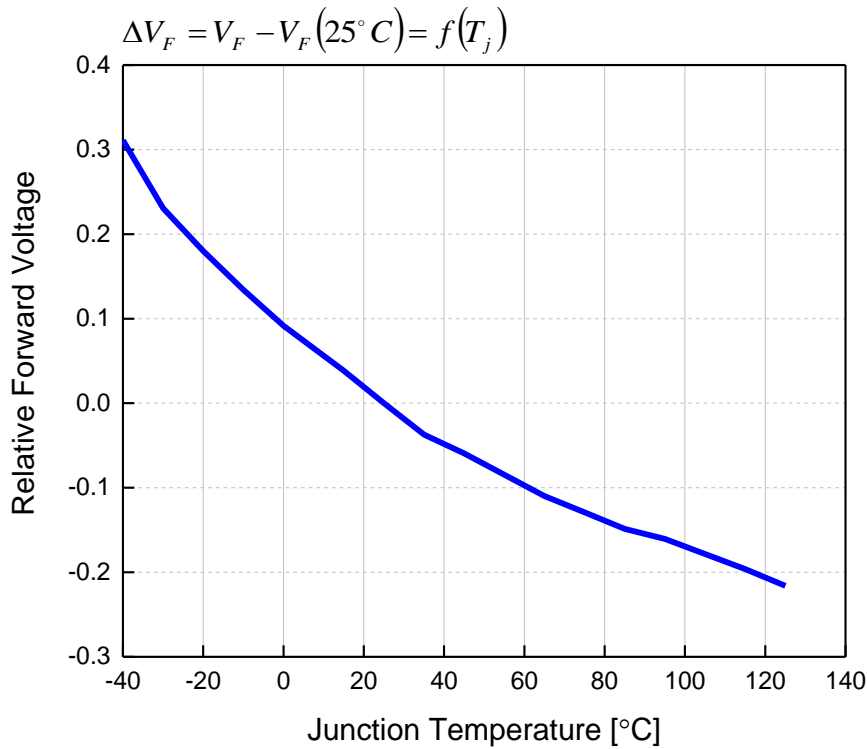

Relative Luminous Flux vs. Junction Temperature
@ $I_F=80\text{mA}$

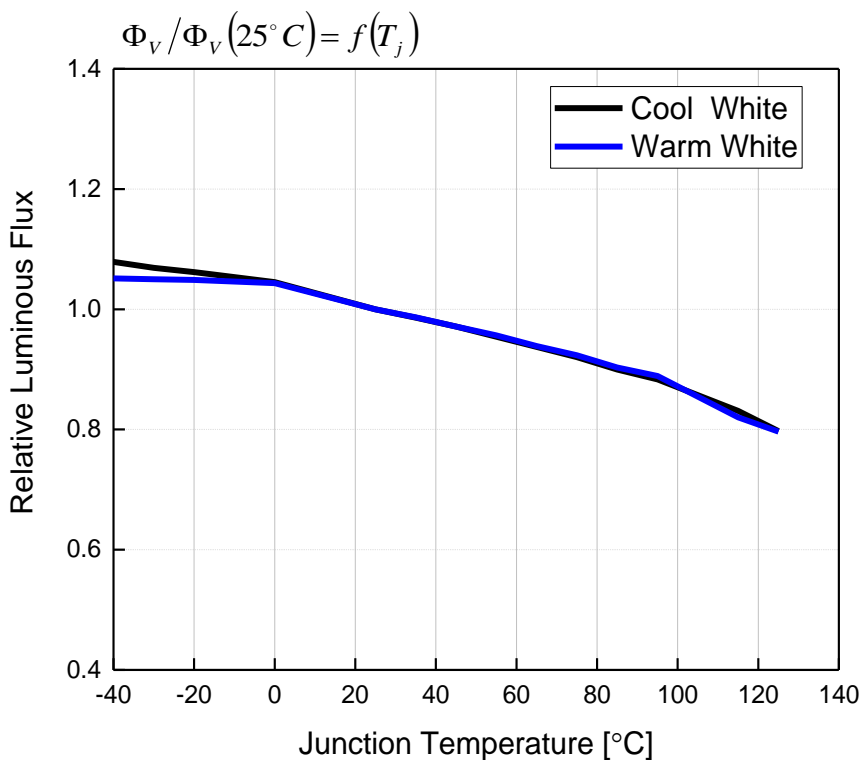

Chromaticity Coordinates Shift vs. Junction Temperature
@ $I_F=80\text{mA}$ (CW)

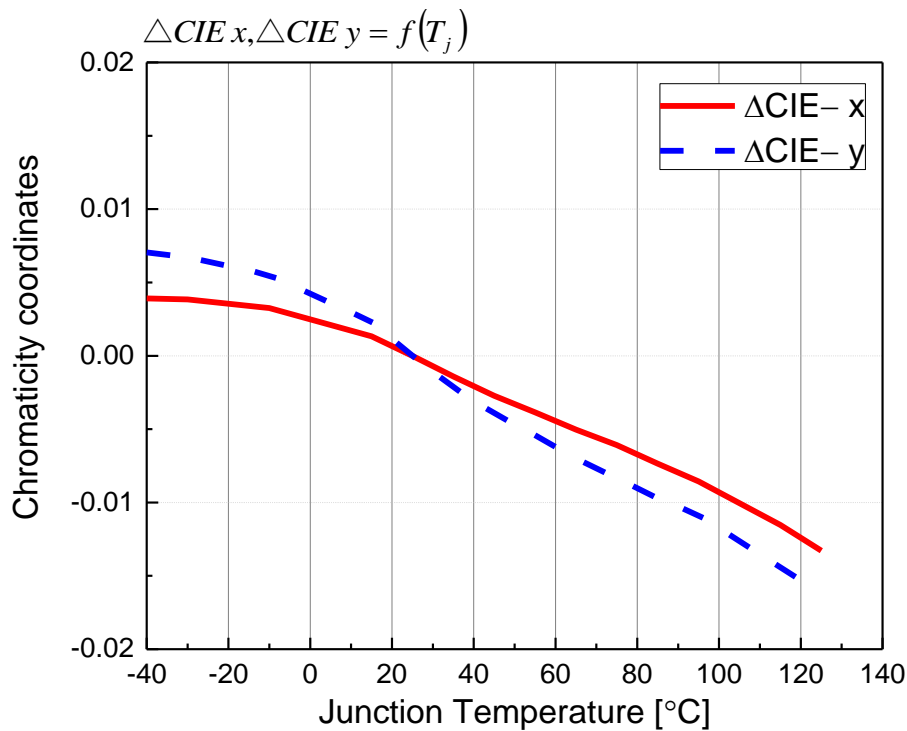

Chromaticity Coordinates Shift vs. Junction Temperature
@ $I_F=80\text{mA}$ (WW)

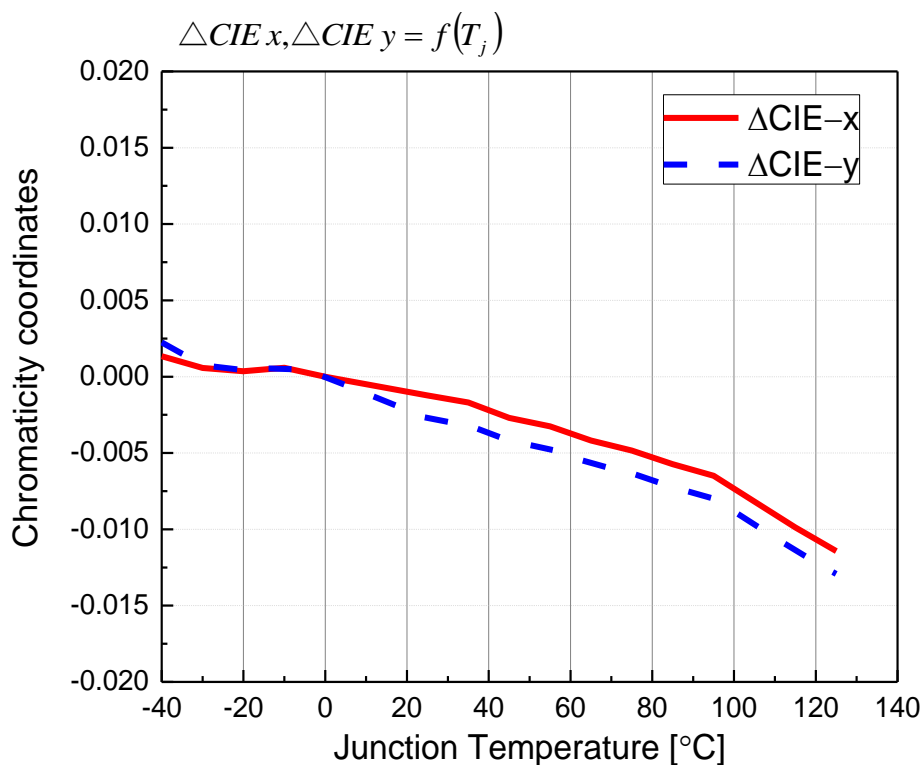

Forward Current Derating Curve

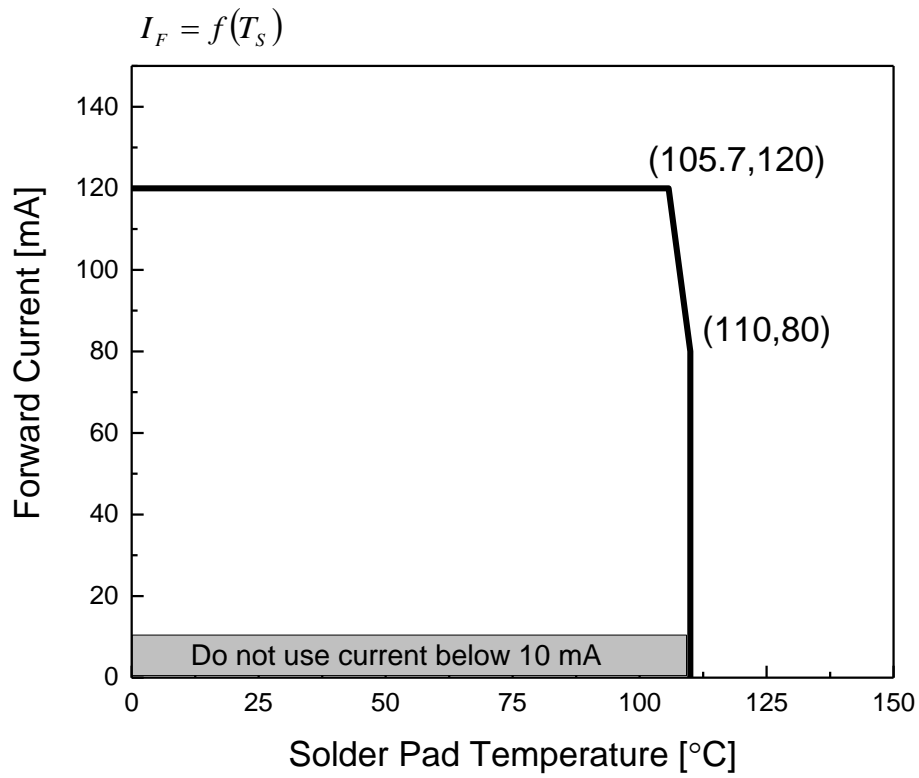

4. Binning Information

Luminous Intensity Bins

Group	Bin	Minimum Photometric Flux (lm)	Maximum Photometric Flux (lm)
E	1	4	5
	2	5	6
	3	6	8
	4	8	10
	5	10	13
	6	13	17
	7	17	20
	8	20	23
	9	23	27
F	1	27	33
	2	33	39
	3	39	45
	4	45	52
	5	52	60
	6	60	70
	7	70	80
	8	80	90
	9	90	100

Group	Bin	Minimum Photometric Flux (lm)	Maximum Photometric Flux (lm)
J	1	100	110
	2	110	120
	3	120	130
	4	130	140
	5	140	150
	6	150	160
	7	160	180
	8	180	200
	9	200	225
K	1	225	250
	2	250	275
	3	275	300
	4	300	325
	5	325	350
	6	350	375
	7	375	400
	8	400	425
	9	425	450

Notes:

- Luminous flux measurement tolerance: $\pm 8\%$.
- Highlighted Black Box is available bins.
 - Cool White : E8 ~ E9
 - Warm White : E8 ~ E9

Color Bin Structure ECE White Bin Structure

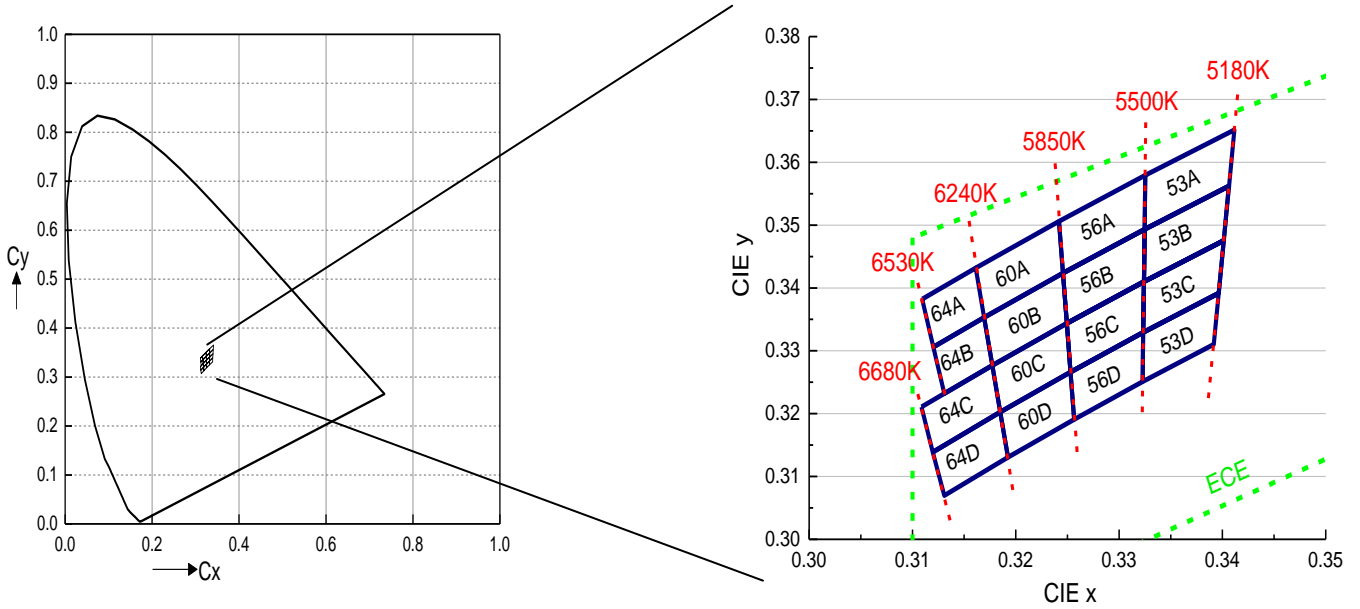

Cool White Bin Coordinates

Bin	CIE x	CIE y
64A	0.3109	0.3382
	0.3161	0.3432
	0.3169	0.3353
	0.3120	0.3306
Reference Range: 6240~6530K		

Bin	CIE x	CIE y
64B	0.3120	0.3306
	0.3169	0.3353
	0.3177	0.3277
	0.3131	0.3232
Reference Range: 6240~6530K		

Bin	CIE x	CIE y
64C	0.3109	0.3211
	0.3177	0.3277
	0.3185	0.3203
	0.3120	0.3139
Reference Range: 6240~6680K		

Bin	CIE x	CIE y
64D	0.3120	0.3139
	0.3185	0.3203
	0.3192	0.3131
	0.3131	0.3070
Reference Range: 6240~6680K		

Bin	CIE x	CIE y
60A	0.3161	0.3432
	0.3242	0.3506
	0.3246	0.3424
	0.3169	0.3353
Reference Range: 5850~6240K		

Bin	CIE x	CIE y
60B	0.3169	0.3353
	0.3246	0.3424
	0.3249	0.3344
	0.3177	0.3277
Reference Range: 5850~6240K		

Cool White Bin Coordinates

Bin	CIE x	CIE y
60C	0.3177	0.3277
	0.3249	0.3344
	0.3253	0.3266
	0.3185	0.3203
Reference Range: 5850~6240K		

Bin	CIE x	CIE y
60D	0.3185	0.3203
	0.3253	0.3266
	0.3256	0.3191
	0.3192	0.3131
Reference Range: 5850~6240K		

Bin	CIE x	CIE y
56A	0.3242	0.3506
	0.3325	0.3579
	0.3325	0.3493
	0.3246	0.3424
Reference Range: 5500~5850K		

Bin	CIE x	CIE y
56B	0.3246	0.3424
	0.3325	0.3493
	0.3324	0.3410
	0.3249	0.3344
Reference Range: 5500~5850K		

Bin	CIE x	CIE y
56C	0.3249	0.3344
	0.3324	0.3410
	0.3323	0.3329
	0.3253	0.3266
Reference Range: 5500~5850K		

Bin	CIE x	CIE y
56D	0.3253	0.3266
	0.3323	0.3329
	0.3323	0.3251
	0.3256	0.3191
Reference Range: 5500~5850K		

Bin	CIE x	CIE y
53A	0.3325	0.3579
	0.3412	0.3652
	0.3406	0.3562
	0.3325	0.3493
Reference Range: 5180~5500K		

Bin	CIE x	CIE y
53B	0.3325	0.3493
	0.3406	0.3562
	0.3401	0.3476
	0.3324	0.3410
Reference Range: 5180~5500K		

Bin	CIE x	CIE y
53C	0.3324	0.3410
	0.3401	0.3476
	0.3396	0.3392
	0.3323	0.3329
Reference Range: 5180~5500K		

Bin	CIE x	CIE y
53D	0.3323	0.3329
	0.3396	0.3392
	0.3392	0.3310
	0.3323	0.3251
Reference Range: 5180~5500K		

Notes:

1. Tolerance of Chromaticity Coordinates x,y : ± 0.005

**Color Bin Structure
ECE Warm-White Bin Structure**

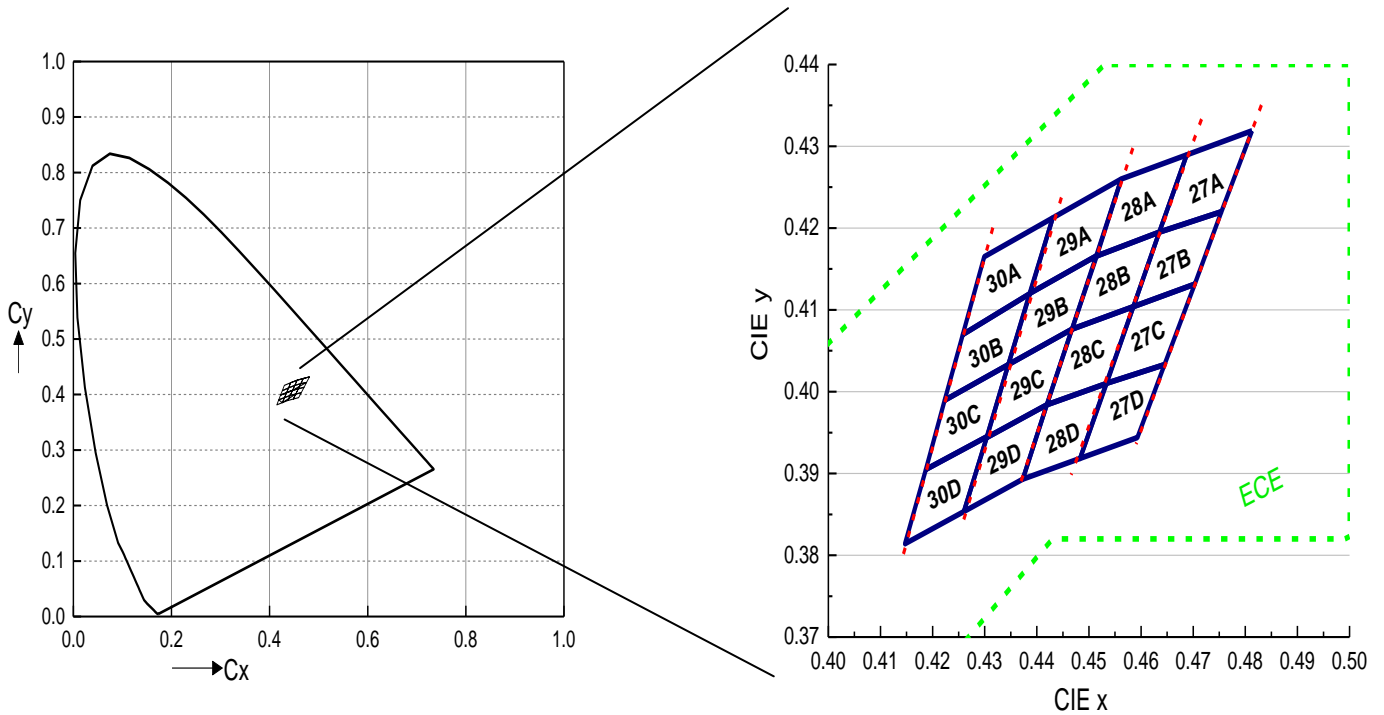

Warm-White Bin Coordinates

Bin	CIE x	CIE y
30A	0.4431	0.4213
	0.4387	0.4120
	0.4258	0.4070
	0.4299	0.4165
Reference Range: 3000~3200K		

Bin	CIE x	CIE y
30B	0.4223	0.3990
	0.4345	0.4033
	0.4387	0.4120
	0.4258	0.4070
Reference Range: 3000~3200K		

Bin	CIE x	CIE y
30C	0.4345	0.4033
	0.4223	0.3990
	0.4187	0.3905
	0.4304	0.3945
Reference Range: 3000~3200K		

Bin	CIE x	CIE y
30D	0.4187	0.3905
	0.4304	0.3945
	0.4260	0.3854
	0.4147	0.3814
Reference Range: 3000~3200K		

Warm-White Bin Coordinates

Bin	CIE x	CIE y
29A	0.4562	0.4260
	0.4514	0.4166
	0.4386	0.4120
	0.4431	0.4213
Reference Range: 2860~3000K		

Bin	CIE x	CIE y
29B	0.4345	0.4033
	0.4468	0.4077
	0.4514	0.4166
	0.4386	0.4120
Reference Range: 2860~3000K		

Bin	CIE x	CIE y
29C	0.4468	0.4077
	0.4419	0.3984
	0.4304	0.3944
	0.4345	0.4033
Reference Range: 2860~3000K		

Bin	CIE x	CIE y
29D	0.4260	0.3854
	0.4373	0.3893
	0.4419	0.3984
	0.4304	0.3944
Reference Range: 2860~3000K		

Bin	CIE x	CIE y
28A	0.4688	0.4290
	0.4635	0.4195
	0.4515	0.4166
	0.4562	0.4260
Reference Range: 2700~2860K		

Bin	CIE x	CIE y
28B	0.4468	0.4077
	0.4585	0.4104
	0.4635	0.4195
	0.4515	0.4166
Reference Range: 2700~2860K		

Bin	CIE x	CIE y
28C	0.4585	0.4104
	0.4534	0.4010
	0.4419	0.3984
	0.4468	0.4077
Reference Range: 2700~2860K		

Bin	CIE x	CIE y
28D	0.4534	0.4010
	0.4419	0.3984
	0.4373	0.3893
	0.4483	0.3919
Reference Range: 2700~2860K		

Bin	CIE x	CIE y
27A	0.4813	0.4319
	0.4754	0.4220
	0.4635	0.4195
	0.4688	0.4290
Reference Range: 2580~2700K		

Bin	CIE x	CIE y
27B	0.4754	0.4220
	0.4635	0.4195
	0.4585	0.4104
	0.4703	0.4132
Reference Range: 2580~2700K		

Warm-White Bin Coordinates

Bin	CIE x	CIE y
27C	0.4585	0.4104
	0.4533	0.4010
	0.4645	0.4033
	0.4703	0.4132
Reference Range: 2580~2700K		

Bin	CIE x	CIE y
27D	0.4533	0.4010
	0.4645	0.4033
	0.4593	0.3944
	0.4483	0.3919
Reference Range: 2580~2700K		

Notes:

1. Tolerance of Chromaticity Coordinates x,y : ± 0.005

Forward Voltage Bins

Bin code	Forward Voltage [V]
10	1.00
12	1.25
15	1.50
17	1.75
20	2.00
22	2.25
25	2.50
27	2.75
30	3.00
32	3.25
35	3.50
37	3.75
40	4.00
42	4.25
45	4.50
47	4.75
50	5.00
52	5.25
55	5.50
57	5.75
60	6.00
62	6.25
65	6.50
67	6.75
70	7.00

Notes:

- Bin code defines either Minimum or Maximum Value of the Bin.
- Forward voltage bins are defined at $I_F = 80\text{mA}$ operation.
- Highlighted Black Box is available bins.
 - Cool White : 27 ~ 35
 - Warm White : 27 ~ 35

5.Part Number

CH1216-C8W80801H-AM

Part number is designated with below details.

CH1216 = Product family name.

C & W = Color ^[1]

8 = CRI (0=N/A ; >70%=7 ; >80%=8 ; >90%=9)

080 = Test current [mA]

1 = Metallic Plating Type (0=Ag ; 1=Au)

H = Brightness Level (H=High ; L=Low)

AM = Automotive Application

Note

^[1] Color :

Symbol	Description
C	Cool White
N	Neutral White
W	Warm White
PA	Phosphor Converted Amber
PR	Phosphor Converted Red
UB	Blue
IB	Ice Blue
SB	Sky Blue
UG	Green
UY	Yellow
UA	Amber
UR	Red
SR	Super Red
RGB	RGB – Color
RGBY	RGBY – Color

6. Ordering Information

CH1216-C8W80801H-ABC-DE-AM

Part Number of the CH1216	Order Code
CH1216-C8W80801H-AM	CH1216-C8W80801H-A00-2T-AM

Order code contains information with below details :

ABC = Product emits 2 or more colors

DE = Internal code

AM = Automotive Application

Note

^[1] Group Bin chart :

Group Bin	CIE-X Y	Φ_v	V_F
A00	53A64D 27A30D	E8E9 E7E8	2735
A01	60C64D 27A28B	E8E9 E7E8	2735
A02	60C64D 28B29C	E8E9 E7E8	2735
A03	60C64D 29C30D	E8E9 E7E8	2735
A04	56B60C 27A28B	E8E9 E7E8	2735
A05	56B60C 28B29C	E8E9 E7E8	2735
A06	56B60C 29C30D	E8E9 E7E8	2735
A07	53A56B 27A28B	E8E9 E7E8	2735
A08	53A56B 28B29C	E8E9 E7E8	2735
A09	53A56B 29C30D	E8E9 E7E8	2735

7. Mechanical Dimension

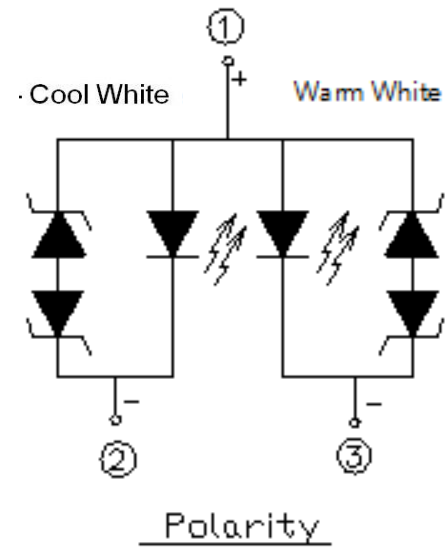
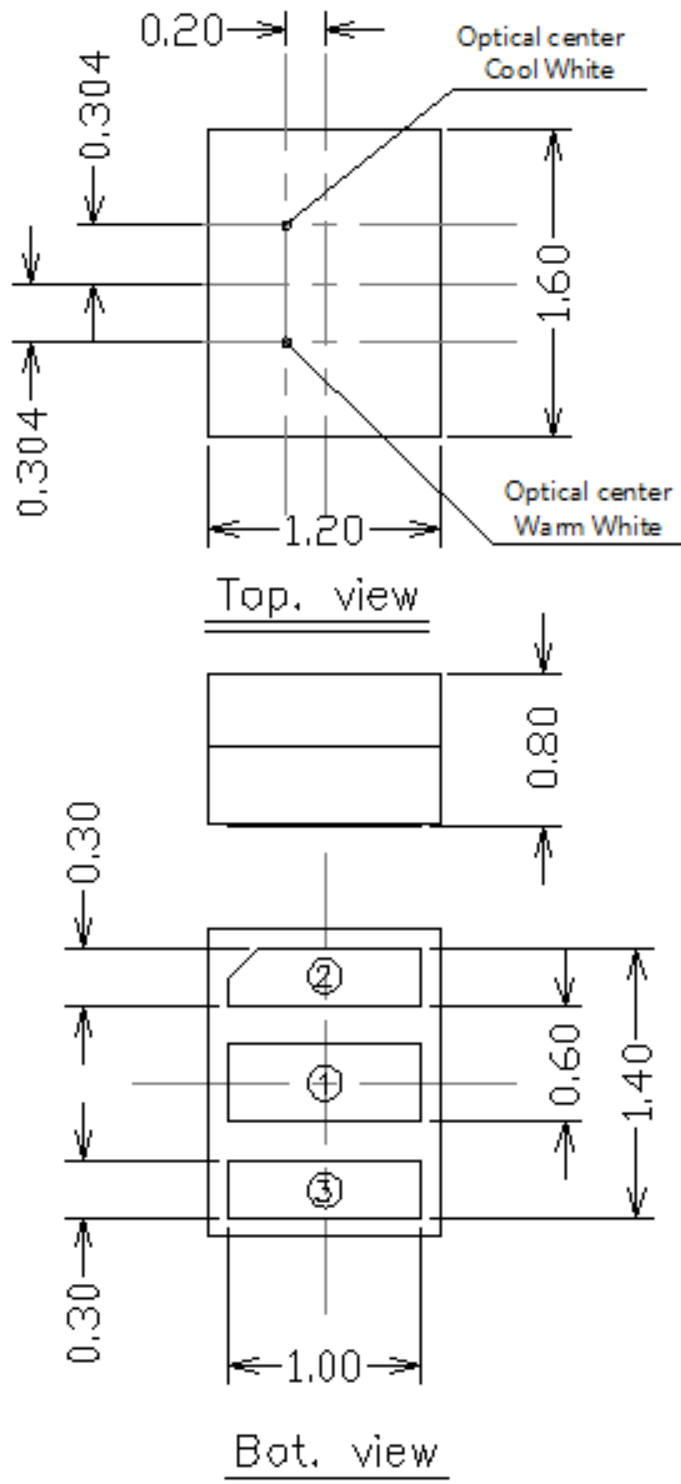

①	Anode
②	Cathode – Cool White
③	Cathode – Warm White

Notes:

1. Dimensions are in millimeters.
2. Tolerances unless mentioned are $\pm 0.1\text{mm}$.

8. Recommended Soldering Pad

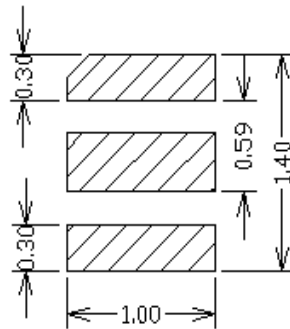

9. Reflow Soldering Profile

Soldering Condition (Reference: IPC/JEDEC J-STD-020D)

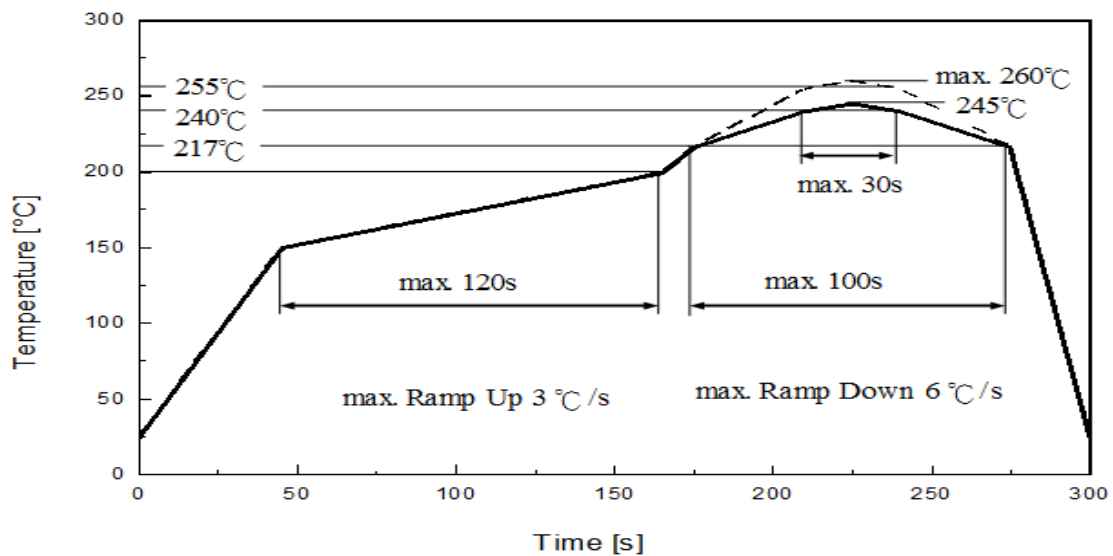

Profile Feature	Pb-Free Assembly	Unit Einheit
	Recommendation	
Ramp-up rate to preheat 25 °C to 150 °C	3	°C /sec
Time of soaking zone 150 °C to 200 °C	120	sec
Ramp-up rate to peak	3	°C /sec
Liquidus temperature	217	°C
Time above liquidus temperature	100	sec
Peak temperature (max.)	260	°C
Time within 5°C of the specified peak temperature	30	sec
Ramp-down Rate (max.)	6	°C /sec

10. Packaging Information

● Product Labeling



- CPN : Customer's Product Number
- P/N : Everlight Part Number
- QTY : Packing Quantity
- CAT : Luminous Flux (Brightness) Bin
- HUE : Color Bin
- REF : Forward Voltage Bin
- LOT No : Lot Number

● Packing: Loaded Quantity 2000 pcs Per Reel

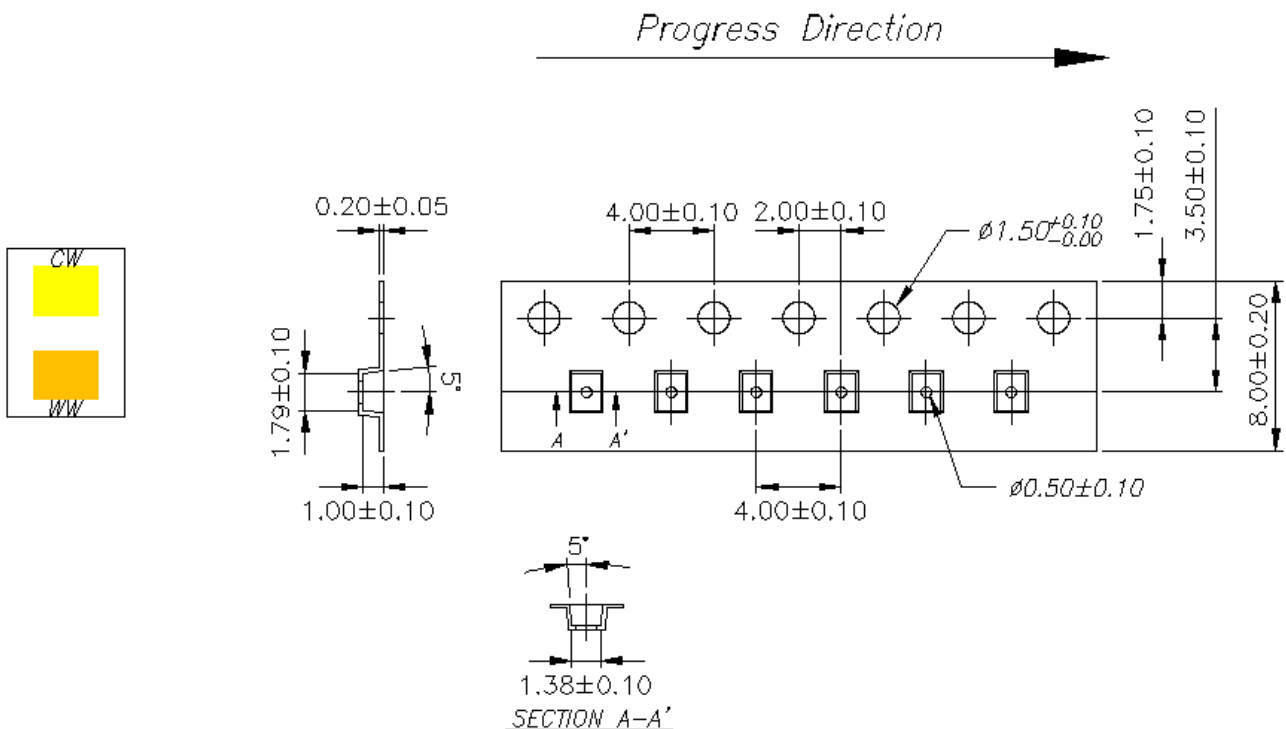

Notes:

1. Dimensions are in millimeters.
2. Tolerances for fixed dimensions are $\pm 0.2\text{mm}$.

● **Reel Dimensions**

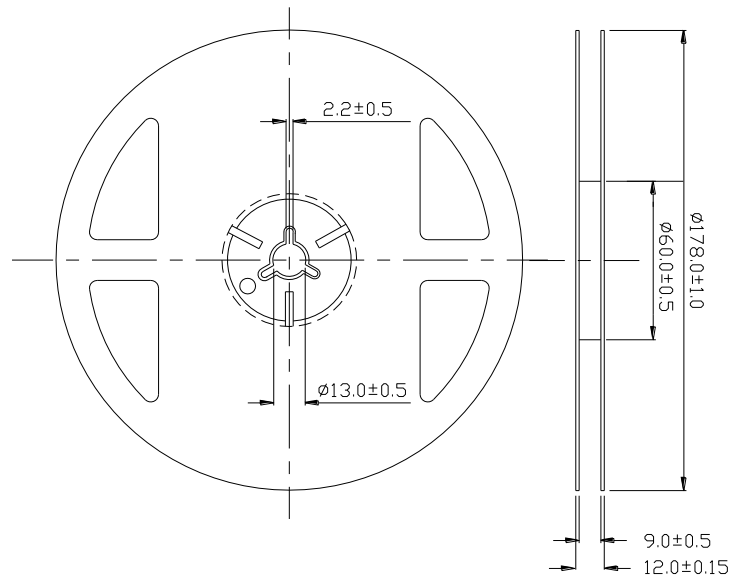

Notes:

1. Dimensions are in millimeters.
2. Tolerances unless mentioned are ± 0.2 mm.

● **Moisture Resistant Packing Process**

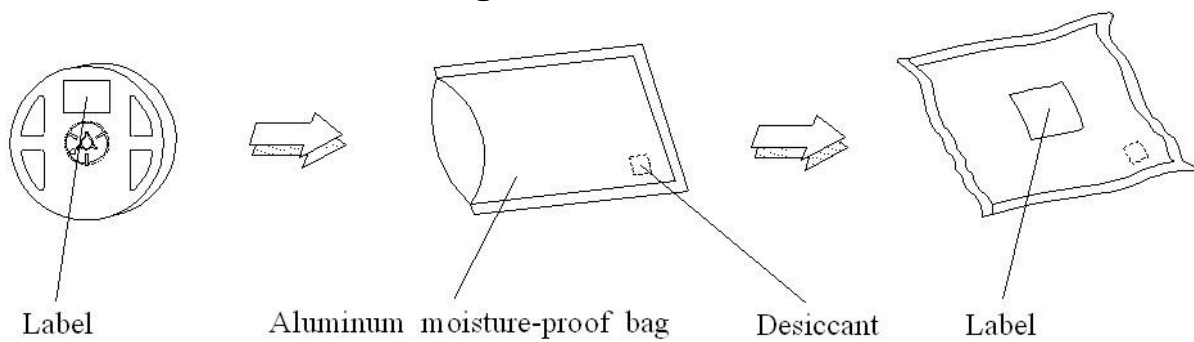

Notes:

1. Dimensions are in millimeters.
2. Tolerances unless mentioned are ± 0.2 mm.

11. Handling of Silicon Resin for LEDs

- Do not put mechanical stress on the LED.
- When handling the product, do not apply direct pressure on the optical surface. The LED surface could be damaged, which could affect the optical performance of the LED.
- In low-humidity work environment, please keep handling the LEDs with appropriate ESD grounding.
- It is recommended to handle the LED with powder-less latex gloves.
- Do not touch the resin with tweezers to avoid scratching or other damage.



12. Precaution for Use

- Before the package is opened, the LEDs should be stored at 30°C or less and 90%RH or less after being shipped from Everlight and the storage life limits are 18 months. The LEDs can be stored up to 3 years in a sealed container with a nitrogen atmosphere and moisture absorbent material.
- After opening the package, all unused LEDs are recommended to be stored in moisture proof packages.
- If the moisture absorbent material (silica gel) has exceeded effectiveness or the LEDs have exceeded the storage time, baking treatment should be performed using the following conditions. Baking treatment: 60±5°C for 24 hours.

Revision History

Current version: Mar.24.2017

Issue No: Preliminary

Version: 0.7

Created by: Sam Lu

Rev.	Subjects (major change in previous version)	Modified date
0.7	Preliminary	2017/03/24